

User's Manual



375
FIELD COMMUNICATOR

375 FIELD COMMUNICATOR

NOTICE

Read this User's Manual before working with the Model 375 Field Communicator. For personal and system safety, and for optimum product performance, thoroughly understand the contents before using or servicing this product.

For equipment service needs, contact the nearest product representative.

© 2003 Emerson Process Management. All rights reserved.

The Emerson logo is a trademark and service mark of Emerson Electric Co.

Rosemount and SMART FAMILY registered trademarks of Rosemount Inc.

IrDA is a registered trademark of the Infrared Data Association.

FOUNDATION is a trademark of the Fieldbus Foundation.

HART is a registered trademark of the HART Communication Foundation.

Hitachi is a registered trademark of Hitachi America, Ltd.

All other marks are the property of their respective owners.

U.S. and foreign patent numbers are pending.

TABLE OF CONTENTS

SECTION 1

Introduction

Using this Manual	1-1
--------------------------------	------------

SECTION 2

Learning the Basics

Overview	2-1
Safety Messages	2-1
Installing the System Card and the battery pack	2-2
Starting Up and Shutting Down	2-3
Starting the 375 Field Communicator	2-4
Shutting down	2-4
Basic Features and Functions	2-5
Using the keypad	2-6
On/off key	2-6
Four arrow navigation keys	2-6
Enter key	2-6
Tab key	2-6
Alphanumeric keypad	2-7
Backlight adjustment key	2-7
Function key	2-8
Multifunction LED	2-8
Using the touch screen	2-8
Using the Soft Input Panel (SIP) keyboard	2-9

Viewing The 375 Main Menu	2-9
Running the HART application	2-10
Running the Settings menu	2-10
About 375	2-10
Backlight	2-10
Clock	2-11
Contrast	2-11
Event capture	2-11
License	2-12
Memory	2-12
Power	2-12
Touch screen alignment	2-13
Exit to the 375 Main Menu	2-13
Communicating with a PC	2-14
IrDA communication with PCs	2-14
Listen For PC	2-14
Transferring HART configurations using AMS	2-15
Programming Utility	2-15
Using the ScratchPad application	2-16
Create a new document	2-17
Open an existing document	2-17
Enter text	2-17
Select text	2-17
Cut text	2-18
Copy text	2-18
Paste text	2-18
Undo text	2-18
Save a document	2-18
Save a copy	2-19
Delete a document	2-19
Exiting ScratchPad	2-19
Managing Storage	2-20
Types of storage	2-20

Maintenance	2-21
Battery Information	2-21
Checking the charge remaining	2-21
Charging the battery	2-22
Removing the System Card and battery pack	2-22
Running a self test	2-22
Working in an Intrinsically Safe (IS) area	2-23
Waste disposal	2-23

SECTION 3

HART Functionality

Overview	3-1
Safety Messages	3-1
Basic Features and Functions	3-2
Interpreting the HART icon	3-2
Starting the HART Application	3-2
Using Fast Key sequences	3-2
Setting up Hot Key options	3-3
Executing Hot Key options	3-4
Removing Hot Key options one at a time	3-4
Removing all Hot Key options	3-4
Working Offline	3-5
Creating new configurations Offline	3-5
Opening saved configurations Offline	3-7
Edit a saved configuration Offline	3-8
Copy a saved configuration Offline	3-9
Send a saved configuration Offline	3-9
Delete a saved configuration Offline	3-9
Rename a saved configuration Offline	3-10
Compare two saved configurations Offline	3-10
Working Online	3-11
Connecting to a HART loop	3-11
Connecting to a HART loop	3-13
Connecting directly to a HART device	3-13
Connecting the optional 250-Ohm load resistor	3-14

Viewing the Online menu	3-14
Viewing the Device Setup submenu	3-16
Process Variables (PV)	3-16
Diagnostics and service	3-16
Basic setup	3-16
Detailed setup	3-17
Review	3-17
Primary Variable (PV)	3-17
Analog Output (AO)	3-18
Lower Range Value (LRV)	3-18
Upper Range Value (URV)	3-18
Viewing the Utility Menu	3-18
Configuring the HART application	3-18
Changing the HART polling option	3-18
Changing ignored status messages	3-20
Storage Cleanup	3-20
Viewing available Device Descriptions	3-21
Simulating an online connection to a HART device	3-21
Viewing HART diagnostics	3-22
DC voltage measurement (HART terminals)	3-22
Disconnecting from a HART device	3-22

SECTION 4

Troubleshooting

Overview	4-1
Troubleshooting suggestions	4-1
Loops	4-2
Sample values	4-2
Error and Status Messages	4-5
Required information for technical assistance	4-8
Contacting Technical Support Personnel	4-8

APPENDIX A

Reference Information

Processor and Memory Specifications	A-1
Microprocessor	A-1
Memory	A-1
Internal Flash	A-1
System Card	A-1
RAM	A-1
Expansion Module	A-1
Physical Specifications	A-1
Weight	A-1
Display	A-1
Keypad	A-2
Power Supply Specifications	A-2
Power supply voltage	A-2
Battery	A-2
Battery operating time	A-2
Battery Charger	A-2
Connection Specifications	A-2
Battery Charger	A-2
HART and Fieldbus Communication	A-2
Personal Computer	A-2
Environmental Specifications	A-3
Usage	A-3
Charge	A-3
Storage	A-3
Storage without batteries	A-3
Enclosure rating	A-3
Shock	A-3
Ordering Information	A-3

APPENDIX B**Approval Information**

Overview	B-1
Approved Manufacturing locations	B-1
European Directive Information	B-1
Equipment and componet directive (94/9/EC)	B-1
Electro Magnetic Compatibility (89/336/EWG)	B-1
Other important guidelines	B-1
Hazardous Locations Certifications	B-2
North American Certifications	B-2
Factory Mutual (FM)	B-2
Canadian Standards Association (CSA)	B-3
European Certifications	B-3
CENELEC Intrinsic Safety	B-3
HART Intrinsically Safe electrical parameters	B-3

Glossary	G-i
-----------------------	------------

Index	I-i
--------------------	------------

SECTION 1 INTRODUCTION

USING THIS MANUAL

The sections in this manual provide information on connecting and operating the 375 Field Communicator.

Section 2: Learning the Basics contains information on settings, types of storage, IrDA[®] communication, using ScratchPad, maintenance, managing files and storage.

Section 3: HART Functionality contains information on starting the HART[®] application, establishing communication with connected HART devices, and configuring the HART Application.

Section 4: Troubleshooting provides solutions to the most common 375 Field Communicator operating problems.

Appendix A: Reference Information provides physical, functional, and performance specifications.

Appendix B: Approval Information contains Hazardous Location Certifications, European directive information, and approval drawings.

NOTICE

Information on starting the FOUNDATION™ fieldbus application, working with connected fieldbus devices, block lists, diagnostics, and parameter functionality will be available in a future release of the 375 Field Communicator User's Manual.

SECTION 2 LEARNING THE BASICS

OVERVIEW

This section provides instructions on basic features and functions of the 375 Field Communicator. It also provides instructions on starting, configuring the settings, using ScratchPad, maintaining, and shutting down the 375 Field Communicator.

SAFETY MESSAGES

Procedures and instructions in this section may require special precautions to ensure the safety of the personnel performing the operation. Information that raises potential safety issues is indicated by a warning symbol () . Refer to the following safety messages before performing an operation preceded by this symbol. Other warning messages can be found in the Troubleshooting section of this manual.

IMPORTANT NOTICE

Ensure the battery pack and the 375 Field Communicator are properly aligned during assembly to prevent damage to the connector pins.

IMPORTANT NOTICE

During assembly/disassembly:

Do not pull up on the battery pack as this could damage the power supply connector.

Do not pull up on the System Card as this could damage the card or the System Card socket.

⚠ WARNING

Contact with the touch screen should be made by blunt items only, preferably the stylus included with the 375 Field Communicator. The use of sharp instruments, such as screwdrivers, can cause failure of the touch screen interface.

⚠ WARNING

Initiating a Re-Flash initiates reinstallation of the system software from the System Card. This should only be performed under the direction of technical support personnel.

**INSTALLING
THE SYSTEM
CARD AND
THE BATTERY
PACK**

1. Place the 375 Field Communicator face down on a level, secure surface, see Figure 2-1.
2. Lock the stand into the hanger position. To pivot past the stand position, squeeze the stand together near the hinge.

Figure 2-1. . Back side of the 375 Field Communicator

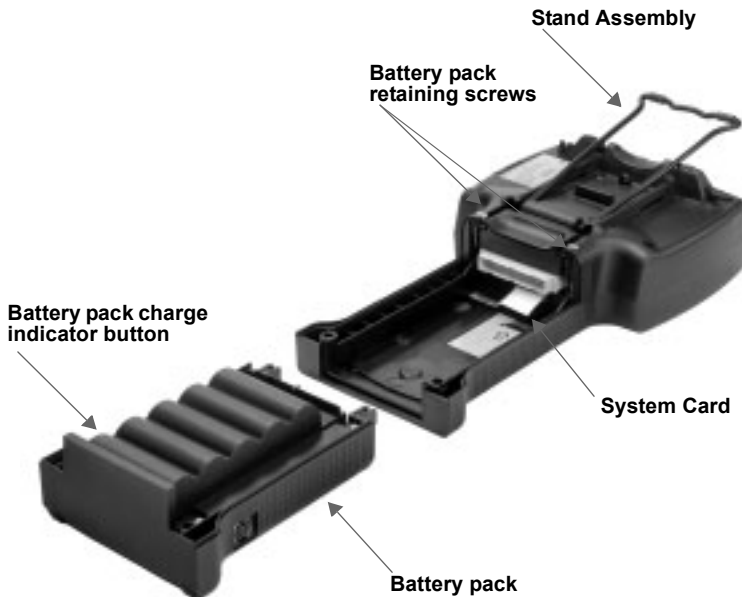

3. With the battery pack removed, place the System Card, with the card contacts facing up, on the main unit System Card guide ribs (located directly below the battery pack connector). Insert the System Card until it is firmly in place.
 4. With the main unit still face down, ensure the tops of the two battery pack retaining screws are flush with the top of the battery pack.
 5. Install the battery pack by aligning the sides of the battery pack and main unit and carefully sliding the battery pack forward until it is secure.
-  If the battery pack and main unit are not properly aligned, the connector pins can be damaged.
6. Tighten the two battery pack retaining screws until they are secure (do not overtighten). The tops of the screws should now be close to flush with the stand groove.

STARTING UP AND SHUTTING DOWN

Prior to using the 375 Field Communicator without the power supply, fully charge the battery pack. A full charge is indicated by a solid green light on the charger/power supply. Charging may take up to two hours. The 375 Field Communicator may be used while charging. Before operating the 375 Field Communicator, ensure:

- The 375 Field Communicator is not damaged.
- The battery pack is fully seated.
- All screws are sufficiently tightened.
- An Expansion Module (EM) or Expansion Port Plug is in place.
- The communication terminal recess is free of dirt and debris.

**Starting the
375 Field
Communicator**

Press and hold the on/off key until the Multifunction LED flashes to indicate the unit is powering (approximately two seconds). See Figure 2-2 for on/off key location.

During start-up, the 375 Field Communicator will automatically perform any software upgrades available on the System Card. Once complete, the 375 Main Menu will be displayed. After starting the 375 Field Communicator, you can choose to:

- Launch the HART or FOUNDATION fieldbus Applications
- Configure/view Settings
- Listen for PC
- Launch the ScratchPad application

Shutting down

While applications are open, the on/off key is disabled. You must exit to the 375 Main Menu before using the on/off key. To shut down the 375 Field Communicator press and hold the on/off key until the display turns off (approximately three seconds).

BASIC FEATURES AND FUNCTIONS

Figure 2-2. 375 Field Communicator diagram



Using the keypad

The 375 Field Communicator keypad and touch screen have nearly total functional redundancy.

On/off key

The on/off () key is used to power on and off the 375 Field Communicator.

You can also power the 375 Field Communicator off by simultaneously pressing the backlight adjustment key and the function key until the display turns off. This is a mechanism by which the power down is accomplished in the hardware (similar to removing the power to a PC using a switch). This is not the recommended way of shutting off the 375 Field Communicator.

Four arrow navigation keys

Four arrow navigation keys allow you to move through the menu structure of the applications. Press the right arrow navigation key () to navigate further into the menu.

Enter key

The enter () key allows you to perform the focused item or to complete an editing action and does not navigate you through the menu structure. For example, if you have the **Cancel** button in focus (highlighted) when you push the enter key, you will be choosing to cancel out of that particular window.

Tab key

The tab () key allows you to move between selectable controls.

Alphanumeric keypad

The alphanumeric keypad allows you select to both letters, digits, and other characters, such as punctuation marks. It can perform a selection of options and data entry in either numeric or alphanumeric modes. The 375 Field Communicator will automatically determine the mode depending upon the input necessary for the particular field.

When in alphanumeric mode, to enter text press the desired keypad button in quick repetition to scroll through the options to achieve the appropriate letter or number. For example, to type the letter Z, press the 9 key quickly four times, see Figure 2-3.

Figure 2-3. Keypad button functionality example



Backlight adjustment key

The backlight adjustment () key allows you to adjust the intensity of the display. There are four different settings. Intensity impacts the battery life of the 375 Field Communicator. Expect a shorter battery life for higher intensities, see “Backlight” on page 2-10 for settings.

Function key

The function () key allows you to enable alternate functionality on select keys. The grey characters on the keys indicate the alternate functionality. When enabled, the orange multifunction LED light will appear and an indication button can be found on the SIP. If the function key is enabled, press the key again to disable the functionality.

The alternate function on the Tab and alphanumeric 5 key (insert) will be activated in future releases of the 375 Field Communicator.

Multifunction LED

The multifunction LED allows you to recognize when the 375 Field Communicator is in various states, see Table 2-1.

Table 2-1. Multifunction LED

Multifunction LED	Processing indication
Green	The 375 Field Communicator is on.
Flashing Green	The 375 Field Communicator is in power saving mode. The display is off.
Green and Orange	The Function key is enabled.
Flash green and orange	The on/off button has been held down long enough for power up.

Using the touch screen

The touch screen display allows you to select and enter text by touching the window. Tap the window once to select a menu item or to activate a control. Double-tap to move further into the menu level.

NOTE

All instructions in this manual are written for the touch screen.

⚠ The touch screen should be contacted by blunt items only, preferably the stylus included with the 375 Field Communicator. The use of sharp instruments, such as screwdrivers, can cause failure of the touch screen interface. Repair of the touch screen requires replacement of the entire 375 Field Communicator display assembly, which is possible only at an authorized service center.

Use the back arrow button (←) to return to the previous menu. Use the terminate button (✕) in the upper right corner of the touch screen to end the application.

Using the Soft Input Panel (SIP) keyboard

The SIP keyboard allows for alphanumeric input using the touch screen. The SIP keyboard detects when you need to enter characters and will appear automatically as required.

VIEWING THE 375 MAIN MENU

The 375 Main Menu allows you to run the HART application, run the Settings menu, communicate with your PC, and launch the ScratchPad application.

Figure 2-4. 375 Main Menu

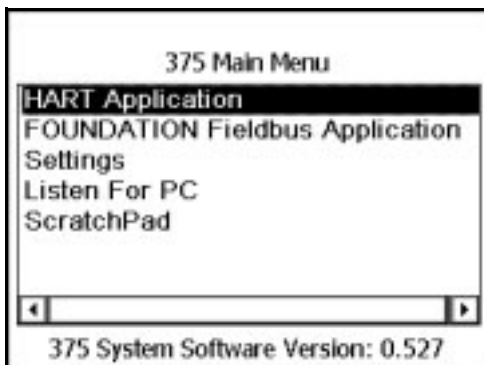

Running the HART application

From the 375 Main Menu double-tap **HART Application** to run the HART application. On startup, the HART Application will automatically poll for devices.

Running the Settings menu

From the 375 Main Menu double-tap **Settings** to view the Settings menu. The Settings menu allows you to set preferences for the 375 Field Communicator. The Settings menu also allows you to view system properties and license information.

To adjust the 375 Field Communicator settings:

1. From the 375 Main Menu select **Settings**.
2. Select the desired setting from the Settings menu.

About 375

About 375 allows you to view the software property revisions of your particular 375 Field Communicator. If you need to call technical support, have the System Software version, Communication and Diagnostic Circuitry (CDC) version, and the Operating System version on hand.

 Launching the RE-FLASH initiates the reinstallation of the system software from the System Card. This should only be performed under the direction of technical support personnel.

Backlight

The backlight setting allows you to adjust the intensity of the display. To adjust the backlight, drag the slider left to right. When you find an appropriate backlight setting select **OK** for this session only, **SET DEFAULT** to retain this setting upon start up, or **CANCEL** to exit without changes.

Clock

The clock setting allows you to set the date and time on the 375 Field Communicator. Configure the date by using the drop down menu. To configure the time, highlight the appropriate time field and use the arrows to scroll through values until you find the correct time. Select **OK** to close.

Contrast

The contrast setting allows you to adjust the lightest and darkest areas on a display screen.

To adjust the contrast, drag the slider left or right. The window will automatically adjust the contrast as you move the slider. When you find an appropriate contrast setting select **OK** for this use only, **SET DEFAULT** to retain this setting upon start up, or **CANCEL** to exit without changes.

NOTE

Contrast can be effected by temperature.

Event capture

The event capture setting allows you to turn on and off the event captures and also allows you to delete event capture (.rec) files. An event capture is a log of communication, input, and screen output that occurs between the 375 Field Communicator and a device.

1. Activate event capture in the settings menu by tapping the desired radio button. The radio button will be highlighted white when selected. To delete an event capture tap the **DELETE EVENT FILE** button.

With event capture enabled, starting the HART application will activate an event capture dialog box for you to enter a file name. Enter the name

and tap **OK**. The file will be saved to a default location.

NOTE

While event capture is enabled, device warning messages will not appear.

Event captures are helpful in troubleshooting.

1. Create an event capture.
2. Transfer the event capture to a PC with the Programming Utility, see Programming Utility Help for more information.
3. Email the event capture to technical support personnel who will then be able to view the specific communication.

License

Licensing can be viewed when you turn on the 375 Field Communicator and in the license settings menu. The license setting allows you to view the license on the System Card. The HART application license is standard in every 375 Field Communicator. Other licenses available include the FOUNDATION fieldbus application and Easy Upgrade option. Unlicensed features cannot be accessed.

Memory

The memory setting allows you to view the total memory storage and available free space in the System Card, Internal Flash, RAM, and Expansion Module (if installed).

Power

The power setting allows you to specify power management and to view battery/charge status. To specify the power management settings select the time interval from the drop down menus.

The power saving mode will turn off the backlight, the display and reduce power consumption to a minimum. The green multifunction LED light will flash while in power saving mode. To exit out of the power saving mode press any key or tap the touch screen. The 375 Field Communicator will return to the previously running mode.

The auto-off will turn off the 375 Field Communicator after the specified duration of inactivity.

NOTE

The auto-off functionality will be disabled automatically during certain operations to prevent the unintentional loss of data.

When you determine an appropriate power management setting select **OK** for this session only, **Set Default** to retain this setting upon start up, or **Cancel** to exit without changes.

Power supply is indicated at the bottom of the screen. When on battery power, a percent charge remaining bar will be present. A message will appear when on external power.

Touch screen alignment

The touch screen alignment setting allows you to calibrate the touch screen with the display. Tap the cross hairs firmly and accurately at each location on the window. The target will continue to move until the touch screen is aligned. Touch screen alignment will be retained upon start up.

Exit to the 375 Main Menu

Double-tap **Exit to 375 Main Menu** if you want to return to the 375 Main Menu.

Communicating with a PC **IrDA communication with PCs**

The 375 Field Communicator communicates with PCs using infrared technology. IrDA is the only PC interface supported for the transfer of device descriptions, software updates, configurations, event captures, and ScratchPad files.

IrDA communication can either be built into the PC or provided through an adapter such as a USB to IrDA adapter or a serial to IrDA adapter. Refer to your IrDA manual for operating instructions.

Throughput for infrared communications with the 375 Field Communicator is approximately 4 kilobytes/second. Maximum recommended distance between the IrDA and PC is 18 inches.

Listen For PC

In Listen for PC, the 375 Field Communicator is under the control of a PC application for transferring data and managing device configurations. The PC application could be one of the following:

- Emerson Process Management AMS (version 6.2 or higher), software for managing instrumentation and valves in a process plant. Currently, AMS only supports HART configurations. In the future, it will also support FOUNDATION fieldbus configurations.
- 375 Field Communicator Programming Utility, a PC-based application for sending files to and receiving files from a 375 Field Communicator.

To enter Listen for PC mode:

1. From the 375 Main Menu, select **Listen for PC**.
2. Align the 375 Field Communicator IrDA interface with the PC IrDA interface.
3. Complete the necessary transfer(s) using the Programming Utility or AMS, see the Programming Utility Help for more information.
4. Tap **EXIT** to close the Listen for PC application.

If new system software was downloaded to the 375 Field Communicator System Card, an update of the Internal Flash will occur.

Transferring HART configurations using AMS

A licensable AMS (version 6.2 or higher) option lets you use the 375 Field Communicator with AMS.

1. Align the 375 Field Communicator IrDA interface with the PC IrDA interface then enter Listen for PC mode. A 375 Field Communicator icon will appear in AMS to indicate that all configurations from the 375 Field Communicator can be accessed.
2. In AMS double-click the 375 Field Communicator icon. The Expansion Module and Internal Flash folders are displayed. Once all of the configuration files are displayed perform your tasks with AMS.

Programming Utility

To add Device Descriptions (DDs) or system software upgrades you will need to have a System Card with the Easy Upgrade option. For more details see the Programming Utility Help.

All 375 Field Communicators come with the basic ability to transfer event captures and text files.

Using the ScratchPad application

From the 375 Main Menu double-tap **ScratchPad** to run the ScratchPad application. ScratchPad is a text editor that you can use to create, open, edit and save simple text (.txt) documents. You are able to transfer .txt files between a PC and the 375 Field Communicator using the Programming Utility. ScratchPad only supports very basic formatting. You can also launch the ScratchPad application from within the HART application by tapping the ScratchPad () icon in the upper right corner of the display. This will automatically open the ScratchPad application.

Once ScratchPad is launched you can perform the following operations.

Figure 2-5. Open blank document in ScratchPad



Create a new document

From the Main Page in the ScratchPad application, tap the **NEW** button. An empty text window and SIP keypad will appear. You are now ready to enter text into your new document.

A new document can also be created within ScratchPad by tapping the New () icon in the toolbar or by selecting **File > New** from the menu.

Open an existing document

1. From the Main Page in the ScratchPad application, select the desired file located under File Name.
2. Tap the **OPEN** button. A text window and the SIP keypad will appear. You are now ready to edit your document.

You can also open a document by selecting **File > Open** from the menu bar or by tapping the Open () icon in the toolbar.

Enter text

Using the stylus, tap the desired letters from the SIP keyboard. Using the keypad, press the desired keypad button in quick repetitions to display the appropriate letter or number.

Select text

Drag the stylus over the desired text to highlight, or to select all of the text in the document tap **Edit > Select All...**

Cut text

1. Select the text to be cut.
2. Tap **Edit** from the menu bar.
3. Tap **Cut** from the Edit menu.

You can also cut text by selecting text and tapping the Cut () icon in the toolbar.

Copy text

1. Select the text to be copied.
2. Tap **Edit** from the menu bar.
3. Tap **Copy** from the Edit menu.

You can also copy text by selecting text and tapping the Copy () icon in the toolbar.

Paste text

1. Copy the text to be pasted.
2. Tap **Edit** from the menu bar.
3. Tap **Paste** from the Edit menu.

You can also paste text by copying the text to be pasted and tapping the Paste () icon in the toolbar.

Undo text

1. In your document, tap **Edit** from the menu bar.
2. Tap **Undo** from the Edit menu.

Save a document

1. In your document, tap **File** from the menu bar.
2. Tap **Save** from the File menu.
3. Type the file name in the dialog box if your document is new.
4. Tap **OK**.

You can also save a document by tapping the Save () icon in the toolbar.

Save a copy

To save a copy of the current document under another name:

1. In your document, tap **File** from the menu bar.
2. Tap **Save As...** from the File menu.
3. Type the copy file name in the dialog box.

Delete a document

There are three options for deleting a ScratchPad document:

Option 1

1. From the Main Page in ScratchPad, select the file to be deleted.
2. Tap **DELETE**.
3. A warning will appear telling you that the selected file will be permanently deleted. If you are sure you want to delete this file tap **Yes**.

Option 2

1. To delete from your document, tap **File > Delete**.
2. From the Delete File Page, tap the desired file to be deleted.
3. Tap **OK**.
4. A warning will appear telling you that the selected file will be permanently deleted. If you are sure you want to delete this file tap **Yes**.
5. Tap **EXIT** when you are finished deleting files.

Option 3

Delete the .txt file from the Programming Utility. See the Programming Utility Help for more information.

Exiting ScratchPad

1. In your document, tap **File** from the menu bar.
2. Tap **Exit** from the File menu.
3. Tap the **EXIT** button from the Main Page.

MANAGING STORAGE

The 375 Field Communicator system management and storage allows you to view the types of storage, run IrDA communication, transfer configurations, and operate the Programming Utility.

Types of storage

The 375 Field Communicator memory consists of four components:

1. Internal Flash—32MB non-volatile RAM. The Internal Flash memory can store:
 - Twenty-five HART configurations (The optional Configuration Expansion Module (spare part number 00375-0043-0001) will allow you to store more configurations if needed.)
 - HART event captures, FOUNDATION fieldbus statistics, and user generated text files
 - 375 Field Communicator system software
2. System Card (SC)—an internal Secure Digital Card with non-volatile Flash memory. A copy of installable 375 Field Communicator application software exists on every System Card. The System Card also stores all HART and FOUNDATION fieldbus Device Descriptions.
3. RAM—32MB used only for program execution
4. Expansion Module (EM)— an optional removable memory card that snaps into the Expansion Port on the side of the 375 Field Communicator. e.g. The Configuration Expansion Module can store HART device configurations.

MAINTENANCE Any maintenance, repair, or replacement of components not listed below must be performed by specially trained personnel at authorized service centers. You can perform common maintenance procedures on the 375 Field Communicator, as described below:

- Cleaning the exterior. Use only a dry lint-free towel or dampen the towel with a mild soap and water solution.
- Charging, removing, and replacing the battery pack
- Removing and replacing the System Card
- Removing and replacing the Expansion Module or Expansion Port Plug
- Removing and replacing the stand assembly
- Ensuring that all exterior screws are sufficiently tightened
- Ensuring that the Communication Terminal recess is free of dirt and debris (does not require disassembly).

Battery Information

Checking the charge remaining

Use the Settings menu to check the charge remaining, see “Power” on page 2-12.

You can also check the battery charge remaining before you insert a spare battery pack.

1. Remove the battery pack, see “Removing the System Card and battery pack” on page 2-22.
2. Turn the battery pack over and press the battery pack charge indicator button. The indication lights will illuminate based upon the amount of charge remaining in the battery. Each light represents 20 percent of charge remaining. The battery is fully charged when all of the indicator lights are illuminated.

Charging the battery



The battery can be charged while attached to the 375 Field Communicator or charged separately. The indication light on the charger will be green when fully charged, amber when charging, cycle between amber and green when pulse charging, and red if it is unable to charge. Do not attempt to charge the battery pack in hazardous areas.

Charge the 375 Field Communicator battery:

1. Plug the recharger/power supply into a power outlet.
2. Plug the power supply/charger connection into the 375 Field Communicator. The 375 Field Communicator is fully operable while the battery is recharging.

Removing the System Card and battery pack

Remove the System Card and battery pack:

1. Place the 375 Field Communicator face down on a level, secure surface.
2. Loosen the two battery pack retaining screws until the top of each screw is flush with the top of the battery pack.
-  3. Slide the battery off the main unit. Do not pull up on the battery pack as this could damage the power supply connector.
-  4. Grasp the System Card and slide it straight out of the main unit. Do not pull up on the System Card as this could damage the card or the System Card socket.

Running a self test

There is no need, nor is it possible, to perform a manual self test with the 375 Field Communicator. Testing features are done automatically. A warning message will occur if a fault condition is found during these tests.

**Working in an
Intrinsically
Safe (IS) area**

The battery pack can be replaced in Intrinsically Safe areas. The Expansion Module can be installed in hazardous locations while the 375 Field Communicator is still running.

**Waste
disposal**

If it ever becomes necessary to discard any part(s) of the 375 Field Communicator, adhere to the waste-disposal regulations applicable in your locality.

SECTION 3 HART FUNCTIONALITY

OVERVIEW

This section provides instruction on basic HART functionality of the Model 375 Field Communicator. As they become available, the HART Field Communicator menu trees will be located online at www.fieldcommunicator.com.

SAFETY MESSAGES

Procedures and instructions in this section may require special precautions to ensure the safety of the personnel performing the operation. Information that raises potential safety issues is indicated by a warning symbol () . Refer to the following safety messages before performing an operation preceded by this symbol. Other warning messages can be found in the Troubleshooting section of this manual.

WARNING

If you choose to ignore all field device status messages, every message from nuisance to critical will be ignored.

WARNING

Voltage measurements are for reference purposes only. Do not make critical process control decisions based upon this voltage.

BASIC FEATURES AND FUNCTIONS

Interpreting the HART icon

A beating hollow heart icon is displayed when the 375 Field Communicator is communicating with a live HART device (♥). A solid beating heart will replace the hollow heart icon when communicating to a HART loop with a device in burst mode. The HART logo is displayed during periods when communication is not occurring.

NOTE

This is common when only static parameters are listed.

STARTING THE HART APPLICATION

To start the HART application:

1. Turn on the 375 Field Communicator. The 375 Main Menu is displayed with HART as the default application.
2. Double-tap **HART Application**. If a live HART device is connected to the 375 Field Communicator, the HART Application main menu will be displayed automatically with key parameters from the connected device. If a device is not connected, the HART Application main menu is displayed after a few seconds. To navigate back to the 375 Main Menu press the back arrow button. From the HART Application main menu you can choose Offline, Online, or Utility functions. The rest of this section will guide you through the HART Application menus and functions.

Using Fast Key sequences

The Fast Key sequence is a sequence of numerical button presses, corresponding to the menu options that lead you to a given task. The Fast Key sequences are identical to the 275 HART Communicator. See your field device documentation for fast key sequence options.

Setting up Hot Key options

The Hot Key menu is a user-definable menu that can store shortcuts for up to 20 of your most frequently performed tasks. For example, if you change device tags and damping often, you can add options for these functions to the Hot Key menu. Once you are Online the Hot Key will automatically appear in the toolbar. To add a custom option to the Hot Key menu:

1. With the Online menu or any of the submenus open, select the option you want to add to the Hot Key menu.
2. Tap and hold the Hot Key (). The Hot Key Configuration window shows the new option you are adding.
3. Tap **ADD**.
4. Tap **ALL** to add the Hot Key option for all devices supported by the Communicator, or tap **ONE** to add the Hot Key option only for the device type to which you are currently connected.
5. If the message “Mark as read only variable on Hot Key menu” displays, choose one of the following:
 - **YES**: The variable for this option is read-only, meaning users can view but not change its value.
 - **NO**: You can view as well as change the value for this variable.
6. Respond to the message “Display value of variable on Hot Key menu?” by choosing one of the following:
 - **YES**: The value of this variable will appear on the Hot Key menu.
 - **NO**: The Hot Key menu will show the name of the variable but not its value.

7. Tap the **EXIT** button on the Hot Key Configuration window to return to the original menu. The new option is added to the Hot Key menu.

Executing Hot Key options

To use a Hot Key option, you must first properly connect the 375 Field Communicator to a device. You can access the Hot Key menu from any online window. To use a Hot Key option:

1. Connect the 375 Field Communicator to a HART loop or device.
2. Tap the Hot Key. The Hot Key menu is displayed.
3. Double-tap the desired option.

Removing Hot Key options one at a time

To remove individual Hot Key options:

1. Tap and hold the Hot Key (). The Hot Key Configuration window will appear.
2. Select the menu option you want to remove.

NOTE

Range Values is a predefined option and cannot be removed. It provides quick access for viewing or changing the range for a device.

3. Tap the **DEL** button.
4. When you are done, tap **EXIT** to close the Hot Key Configuration window.

Removing all Hot Key options

To remove all Hot Key options currently defined:

1. From the HART main menu, double-tap **Utility**.
2. From the HART Utility menu, double-tap **Configure HART Application**.
3. From the Configure HART Application menu, double-tap **Storage Cleanup**.
4. From the Storage Cleanup menu, double-tap **Hot Key Menu**.
5. Tap **YES** if you are sure you want to delete all the items from the Hot Key menu.

WORKING OFFLINE

The Offline menu allows you to create offline configurations, view and change device configurations stored on the 375 Field Communicator.

There are two types of configurations: device configuration and user configuration. A HART configuration created from a HART device will initially be saved as a device configuration. A HART configuration created Offline will be saved as a user configuration. A HART configuration transferred to a 375 Field communicator from another program will be saved as a user configuration. Editing a device configuration within the 375 Field Communicator will change it to a user configuration.

In the 375 Field Communicator, there is no concept of partial or standard configurations. All configurations are full configurations.

Creating new configurations Offline

Creating a new configuration allows you to create a user configuration for a specific device type and revision. To create a new HART device configuration while working offline:

1. From the HART Application main menu, double-tap **Offline**.
2. From the Offline menu, double-tap **New Configuration**. The manufacturers with device descriptions installed on the 375 Field Communicator are listed.
3. Double-tap the desired manufacturer to expand the list. The models available for the manufacturer are listed.
4. Double-tap the desired model to expand the list. The device revisions available for the selected model are listed.
5. Double-tap the desired device revision.

6. If a warning appears, thoroughly read the warning, tap **CONT.** to accept the warning and proceed, or tap **EXIT** to end creating a new user configuration.
7. Mark the configurable variables you want sent to the HART device. Double-tap **Mark all > OK** to have all variables marked. Double-tap **Unmark all > OK** to clear the marks from all variables. A “+” symbol indicates a mark to send. A “*” symbol indicates a parameter has been edited. To mark and edit variables individually:
 - a. Double-tap **Edit individually** to configure specific variables before sending them to a device.
 - b. Scroll through the list of variables and select the variable you want to mark or edit.
 - c. To change the value for the selected variable, tap **EDIT**, change the value, and tap **ENTER**.
 - d. To mark the selected variable, tap **MARK**. A “+” symbol indicates a mark to send. A “*” symbol indicates a parameter has been edited.
 - e. Repeat steps b through d for other variables as necessary and tap **EXIT** when you are finished.
8. To save a new configuration, double-tap **Save as...** (The SAVE button will automatically bring you to the Save as... menu.)
 - a. To change the location where the configuration is saved, double-tap **Location**, select an option, and tap **ENTER**.
 - b. To specify a name for the configuration, double-tap **Name**, enter the name, and tap **ENTER**.
 - c. Tap **SAVE**.

Opening saved configurations Offline

Once opened, a saved configuration allows you to edit, copy to, send, delete, rename, and compare to other saved configurations. To open a saved configuration:

1. From the HART Application main menu, double-tap **Offline**.
2. From the Offline menu, double-tap **Saved Configuration**.
3. Double-tap the storage location from where you saved the configuration—Internal Flash Contents or Configuration Expansion Module Contents.
4. Double-tap the desired configuration to open the menu selection.

The FILTR button opens a menu that provides both sort and tag filter options. These options allow you to customize your view of saved device configurations.

Sort allows you to group and display device configurations according to your choice of name, tag, or descriptor.

Tag Filter allows you to customize your group for viewing according to what you entered with Sort by picking characters from the device name, tag, or descriptor.

When setting up a filter, you can use two special characters: the period (.) and the asterisk (*). The period replaces a single character of any value. The asterisk is used to represent a string of alphanumeric characters of any value.

For example, if you want to list all configurations that have a tag or name of P - 001 to P - 300. You would enter "P - *" in the filter. If you want to

list configurations that have a tag or name that begins P- 0 and ends with a 7, set the filter to P - 0.7.

The XPAND button allows you to view the tag, manufacturer, device type, descriptor, and the configuration type. Tap **CMPRS** to return to the previous compressed screen.

Choose from the following menu options:

Edit a saved configuration Offline

Edit a saved configuration while working offline:

1. From the Saved Configuration menu, double-tap **Edit**.
2. If a warning appears, thoroughly read the warning, tap **CONT.** to accept the warning and proceed, or tap **EXIT** to end creating a new unit configuration.
3. Mark the configurable variables you want saved in the HART configuration. Double-tap **Mark all > OK** to have all variables marked. Double-tap **Unmark all > OK** to clear the marks from all variables. To mark and edit variables individually:
 - a. Double-tap **Edit individually** to configure specific variables before sending them to a device.
 - b. Scroll through the list of variables and select the variable you want to mark or edit.
 - c. To change the value for the selected variable, tap **EDIT**, change the value, and tap **ENTER**.
 - d. To mark the selected variable, tap **MARK**. A “+” symbol indicates a mark to send. A “*” symbol indicates a parameter has been edited.
 - e. Repeat steps b through d for other variables as necessary.
4. Tap **SAVE** to return to the Contents menu.

Copy a saved configuration Offline

Copy to... allows you to copy a saved configuration to a new storage location.

1. From the Saved Configuration menu, double-tap **Copy to...**
2. Choose the storage location from which you want to open the configuration—Internal Flash or Configuration Expansion Module and tap **ENTER**.
3. Double-tap **Name** and enter the name of the configuration.
4. Tap **SAVE** to copy to a new location.

Send a saved configuration Offline

Send allows you to send the selected configuration to a connected device. From the Saved Configuration menu, double-tap **Send**. The 375 Field Communicator will then send the configuration to a connected device that is compatible with the configuration.

Delete a saved configuration Offline

Delete allows you to remove configurations one at a time. To delete a configuration from the 375 Field Communicator storage:

1. From the Saved Configuration menu, double-tap **Delete**.
2. Tap **Yes** to confirm the deletion.

Rename a saved configuration Offline

Rename allows you to change the name of a saved configuration. To rename a saved HART configuration:

1. From the Saved Configuration menu, double-tap **Rename**.
2. Double-tap the file you want to rename.
3. Enter the new file name and tap **ENTER**.
4. Tap **SAVE**.

Compare two saved configurations Offline

Any two configurations can be compared. However, in order to compare two configurations of the same field device, the following conditions must be met:

- Device type (including manufacturer), device revision, and DD revision must match exactly. A dialog box will appear if the comparison is different, however, you will not be told the differences.
- Configurations can only be compared against other configurations containing the same set of variables. The 375 Field Communicator notifies you if this condition is not met.

The format of data storage must match exactly. The 375 Field Communicator notifies you if this condition is not met.

1. From the Saved Configuration menu, double-tap **Compare**.
2. Choose the storage location—Internal Flash or Configuration Expansion Module and tap **ENTER**.
3. Double-tap **Name** to select the configuration file.
4. Double-tap the desired file to compare.
5. Tap **COMP** to compare the configurations.
6. Tap **OK** when you are finished reading the window.

**WORKING
ONLINE**

The online mode displays data for the HART device to which you are connected. The Online menu displays critical, up-to-date process information that is continuously updated, including device setup, primary variable (PV), analog output (AO), lower range value (LRV), and upper range value (URV). For information about intrinsically safe connections see Appendix B “Approval Information”.

A HART configuration created from a connected HART device will initially be saved as a Device Configuration. Editing a Device Configuration within the 375 Field Communicator will change it to a User Configuration.

The 375 Field Communicator can communicate with a transmitter from the control room, the instrument site, or any wiring termination point in the loop.

**Connecting to
a HART loop**

Connect the 375 Field Communicator with the appropriate connectors in parallel with the instrument or load resistor. The HART connections are not polarity sensitive.

In order for the 375 Field Communicator to function properly, a minimum of 250 ohms resistance must be present in the HART loop.

NOTE

Dynamic variables shown while online represent the digital data being sent from the device.

There are three terminals on the top of the 375 Field Communicator. Two of them are red and one of them is black. Each red terminal is a positive connection for its protocol. The black terminal is a common shared by both protocols. There is an access door to ensure that only one pair of terminals is exposed at any one time, see Figure 3-1. There are several markings to indicate which pair of terminals is for which protocol.

Figure 3-1. HART terminal access door

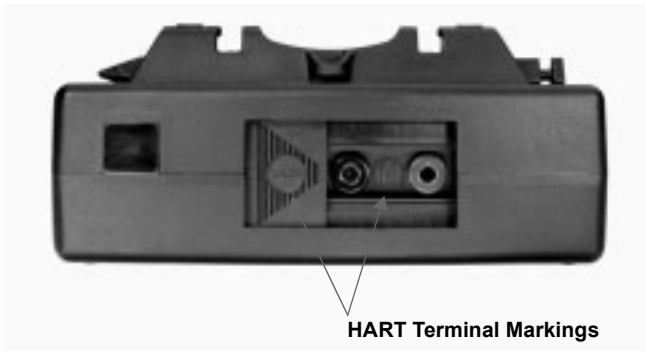

Connecting to a HART loop The following diagram illustrates how to connect the 375 Field Communicator to a HART loop:

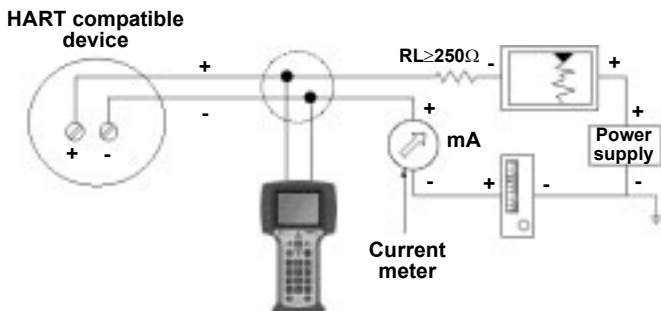

Connecting directly to a HART device The following diagram illustrates how to connect the 375 Field Communicator directly to terminals of a HART device:

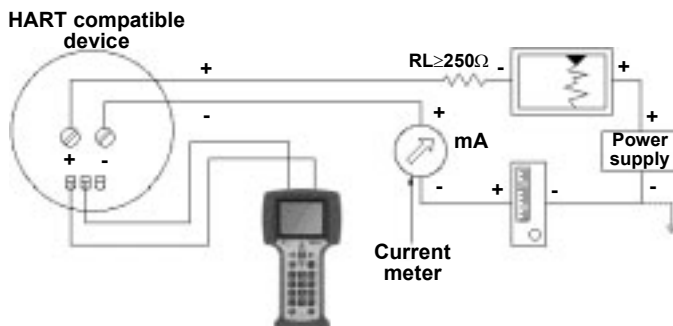

Connecting the optional 250-Ohm load resistor

The following diagram illustrates how to connect the optional 250-ohm resistor. Attaching a resistor is necessary if less than 250 ohms resistance is present in the HART loop.

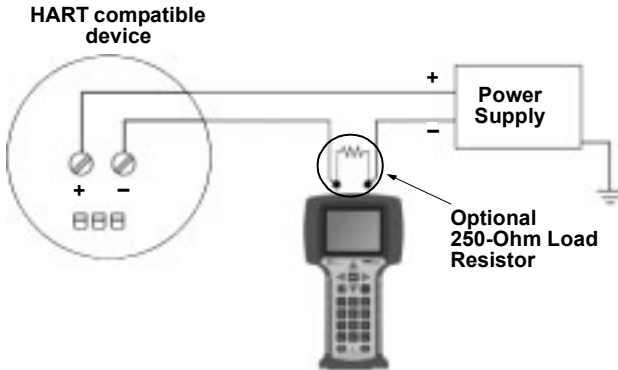

To temporarily install the optional 250-ohm load resistor:

1. Insert the load resistor into the lead set jacks.
2. Open the loop to allow connection of the resistor in series in the loop.
3. Close the loop using the lead set connectors.

VIEWING THE ONLINE MENU

The Online menu is the first menu to appear when connecting to a HART compatible device. It is structured to provide important information about the connected device. This menu displays critical, up-to-date device information including primary variable, analog output, lower range value, and upper range value. See your field device user's manual for more information.

Because of the important information provided in the Online menu, some menus provide instant access to this window. When access is available, the HOME button appears to return you to the Online menu.

Figure 3-2. Online menu example

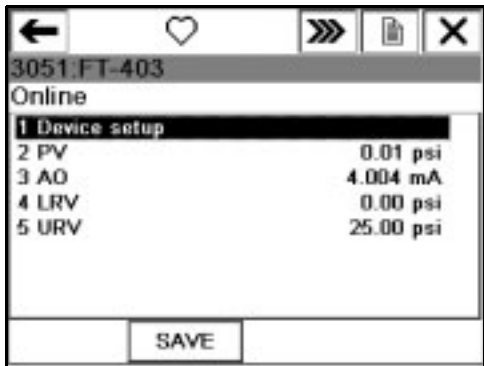

Once you have made changes to the parameters, you may send them to the device. An asterisk will appear next to the parameter name of any un-sent item.

The configuration parameters for devices vary widely from device to device and are defined in the device description. Refer to your field device user's manual for more information. To view process information for a connected device:

1. Connect the 375 Field Communicator to a HART loop or directly to the device.
2. Push the on/off button to turn on the 375 Field Communicator.
3. Double tap **HART Application**. The Online main menu will be displayed automatically.
4. You can view more information about these parameters by choosing the following Online menu options:

Viewing the Device Setup submenu

The Device Setup menu accesses every configurable parameter of the connected device. Double-tap **Device setup** to view the process variables, diagnostics and service, basic setup, detailed setup, and review:

Process Variables (PV)

The PV menu lists all process variables and their values. Process variables are continuously updated when this screen is displayed.

Diagnostics and service

The Diagnostics and Service menu offers device and loop tests as well as calibration options. The diagnostics and service operations that are available vary widely from device to device and are defined in the device description.

Test device menu lists the status as well as self and master test of the device. Test device initiates a diagnostic routine at the device and can report an electronics failure, as well as other failures that can affect performance.

Loop test is used to set the output of the device at a specified analog value, and may be used to test the integrity of the loop and the operation of indicators, recorders, or similar devices in the loop.

Calibration is used to perform such operations as performing a sensor trim, D/A trim, and scaled D/A trim.

Basic setup

The Basic setup menu provides quick access to a number of configurable parameters including tag, unit, range values, and damping.

The options available in the Basic setup menu are the most fundamental tasks that can be performed with a given device. These tasks are a subset of the options available under the Detailed setup menu.

The *Tag* alphanumeric identifies a specific device. Changing units affects the engineering units that are displayed. Reranging changes the analog output scaling. Changing damping effects the response time of the transmitter and is often used to smooth the output when there are rapid input variations.

Detailed setup

The Detailed setup menu provides access to every editable device parameter and all device functions. The Detailed setup menu varies widely from one HART compatible device to another. Functions in this menu can include tasks such as characterization, configuration, and sensor and output trims.

Review

The Review menu lists all of the static parameters read from the connected device, including information about the device and sensor setup and limitations. It also includes information about the connected device such as tag, materials of construction, and device software revision.

Primary Variable (PV)

The Online menu displays critical process information that is continuously updated. If the primary variable and related engineering units are too long, they will not appear on the Online menu. Double-tap **PV** to view when the primary variable and the related engineering units truncated on the Online menu.

Analog Output (AO) The analog output is the signal on the 4–20 mA scale that corresponds to the primary variable. This is a digital value sent from the field device. Double-tap **PV AO** to view when the analog output and its related engineering units are truncated on the Online menu.

Lower Range Value (LRV) Double-tap **PV LRV** to view when the lower range value and its related engineering units are truncated on the Online menu.

Upper Range Value (URV) Double-tap **PV URV** to view when the upper range value and its related engineering units are truncated on the Online menu.

VIEWING THE UTILITY MENU The Utility menu allows you to set the polling option, change the number of ignored status messages, view the available Device Descriptions, perform a simulation, and view HART diagnostics.

Configuring the HART application

Changing the HART polling option

Use the HART polling option to configure your 375 Field Communicator to automatically search for all or specific connected devices. Most HART device installations contain one device per loop and the device address equals zero.

To have more than one device per loop, wire the devices in parallel and placed into “Multidrop” mode. This mode is enabled by changing the address from zero to any address between 1 — 15. After the mode is enabled, the analog output of each device is fixed and no longer represents any variable.

To change the polling option:

1. From the HART main menu, double-tap **Utility**.
2. Double-tap **Configure HART Application**.
3. Double-tap **Polling**.
4. Select one of the following polling options:
 - **Never Poll** - Connects to a device at address 0 and if not found, it will not poll.
 - **Ask Before Polling** - Connects to a device at address 0 and if not found, you will be asked if you want the communicator to poll for devices at addresses 1–15.
 - **Always Poll** - Connects to a device at address 0 and if not found, the communicator will automatically poll for devices at addresses 1–15.
 - **Digital Poll** - Polls addresses 0–15, regardless if a device is found at address 0. To find individual device addresses, use this option to find each connected device in the loop and list them by tag number.
 - **Poll Using Tag** - Allows you to enter the tag of the device. You will be prompted to enter a tag name upon starting the HART Application.
 - **Poll Using Long Tag** - Allows you to enter the long tag of the device. You will be prompted to enter a tag name upon starting the HART Application. (Only supported in HART Universal revision 6 devices.) Double-tap when the tag is truncated to display the full tag.
5. Tap **Enter**.

Refer to your device-specific manual for information about changing a device polling address.

Changing ignored status messages

The 375 Field Communicator displays status messages from all connected HART devices. The Ignore Status option lets you specify the number of field device status messages that are ignored, extending the time between displayed messages. The default is 50 messages. If you choose to ignore all field device status messages, every message from nuisance to critical will be ignored.

To change the number of ignored status messages:

1. From the HART main menu, double-tap **Utility**.
2. Double-tap **Configure HART Application**.
3. Double-tap **Ignore Status**.
4. Enter the number of status messages you want ignored before the next message is displayed. You can specify a number from 50 to 500.
- ⚠ 5. Tap **ENTER**. All field device status messages will be ignored until the quantity specified has been reached.

Storage Cleanup

The Storage Cleanup menu lets you delete the following items:

- **Internal Flash** - By selecting **YES** you will remove all configurations saved in the Internal Flash.
- **Configuration Expansion Module** - By selecting **YES** you will remove all configurations saved in the Configuration Expansion Module.
- **Hot Key Menu** - By selecting **YES** you will delete all items from the Hot Key menu.

Viewing available Device Descriptions

HART Device Descriptions enable the 375 Field Communicator to recognize and configure specific HART-compatible devices. To view the currently installed HART Device Descriptions:

1. From the HART main menu, double-tap **Utility**.
2. Double-tap **Available Device Descriptions**. The manufacturers with device descriptions installed on the 375 Field Communicator are listed.
3. Double-tap the desired manufacturer to expand the list. The models available for the manufacturer are listed.
4. Double-tap the desired model to expand the list. The device revisions available for the selected model are listed.

Simulating an online connection to a HART device

The 375 Field Communicator has a simulation mode that allows you to simulate an online connection to a HART-compatible device without actually connecting to a device. Simulation mode is a training tool that helps you become familiar with devices before configuring them in a critical environment. A simulated configuration cannot be saved.

To simulate a connection to a HART device:

1. From the HART main menu, double-tap **Utility**.
2. Double-tap **Simulation**. The manufacturers with device descriptions installed on the 375 Field Communicator are listed.
3. Double-tap the desired manufacturer to expand the list. The models available for the manufacturer are listed.
4. Double-tap the desired model to expand the list. The device revisions available for the selected model are listed.
5. Double-tap the desired device revision. Refer to the device manual to determine the device revision.

6. If a warning appears, thoroughly read the warning, tap **CONT.** to accept the warning and proceed, or tap **EXIT** to end creating a new unit configuration. (This warning will not appear if your device is tested.) The online menu for the simulated device is displayed. You can now use the 375 Field Communicator as if it were connected to the selected device and perform any online task.

Viewing HART diagnostics

DC voltage measurement (HART terminals)

To check the device voltage:

1. From the HART main menu, double-tap **Utility**.
2. Double-tap **HART Diagnostics**.
3. Double-tap **DC Voltage Measurement**. The DC voltage measurement is displayed. Tap **OK** when done viewing the measurement. Exit the HART Terminal Voltage menu and re-enter to refresh the screen. Voltage measurements are for reference purposes only.

Disconnecting from a HART device

Prior to disconnecting be sure to check the following items:

- Determine if you want to save as a configuration.
- Verify methods (e.g. calibration, loop test) are complete.
- Resolve any un-sent data to the device.

SECTION 4 TROUBLESHOOTING

OVERVIEW

This section provides basic troubleshooting techniques for the Model 375 Field Communicator.

Below are methods for troubleshooting HART Networks that are experiencing problems communicating between a field device and the 375 Field Communicator.

Troubleshooting suggestions

Answer the questions below and use the troubleshooting table, Table 4-4, before calling technical support personnel.

- Does the control system have HART communication capabilities?
- Is it configured to communicate HART currently?

If so, is it reporting communication problems?

If not, stop HART communications on the control system and test communication with the 375 Field Communicator again.

- Is there a barrier installed?
- Is the barrier capable of passing along the HART signal?

Loops

Verify the HART loop current and voltage on the Field device. Almost all field devices need at least 4mA and 12VDC to operate properly.

If there are multiple field devices on a multidrop loop then set the 375 Field Communicator to digital polling mode.

Inspection of the loop wiring can often times reveal problems. The shield is normally grounded at one end only, which is usually the control system.

Verify that the loop has a minimum of 250 ohms resistance. If there is not an external resistor, then normally, the total resistance is the resistance of the process-indicating device monitoring the loop. Check the manuals for the process-indicating device to determine it's loop resistance. If the resistance of the process-indicating device is unknown it can be determined by knowing the current flow in the loop and the voltage across the process-indicating device.

The resistance can be calculated using the formula, Resistance = Voltage / Current. The 375 Field Communicator can be used to measure the voltage, see "DC voltage measurement (HART terminals)" on page 3-22.

Sample values

Loop Current Flow Minimum voltage for 250 ohms.

4 ma 1 Volt

8 ma 2 Volts

12 ma 3 Volts

16 ma 4 Volts

20 ma 5 Volts

If the voltage across the process-indicating device is greater than the value listed for a given current flow then the device has at least 250 of internal resistance. If the voltage is less than the value listed on the table for the given current flow, then more resistance needs to be added to the loop.

If an oscilloscope is available for use then use it to look for noise on the loop. It is necessary to use a scope with differential mode capability to avoid grounding one side of the loop. Noise with a frequency of 800 Hz to 3300 Hz is of particular interest, as this represents frequencies near the HART frequencies of 1200 and 2200 Hz.

Table 4-1. Troubleshooting table for HART protocol

Symptom	Possible Causes	Solution
Intermittent communication	Insufficient loop current and voltage at the field device terminals.	Verify that there is at least 4mA and 12V DC at the field device terminals, see "DC voltage measurement (HART terminals)" on page 3-22.
	Noise on the field loop	
	Noise or signal distortion from the control system (i.e. noise from the power supply powering field devices or front end analog circuitry inside of control system may be distorting the HART signal).	
No communication with field device	Poor wiring	Check wiring terminations and exposed signal wire for damage.
	Insufficient loop resistance at the HART frequencies.	Add an additional 250 ohm resistor in series in the loop. Place the leads across the resistor and verify if communication has been restored.
	Insufficient loop current and voltage at the field device terminals.	Verify that there is at least 4mA and 12V DC at the field device terminals, see "DC voltage measurement (HART terminals)" on page 3-22.
	Field device may be set to HART address other than zero (multi-drop mode).	Change Polling mode to something other than never poll, e.g. Digital Poll.
Control system is communicating HART, but the 375 is not communicating properly.	HART communication is being prevented by the control system.	Stop HART communications on the control system and verify if communication between the field devices and the communicator is restored.

ERROR AND STATUS MESSAGES

General Error Messages	Description
License file check failed - error code x. Please contact service center to resolve this problem. Press OK to turn off. (Where x indicates the test that failed.)	License file check failed during power-up
Battery power is less than 5%. You must recharge the 375 battery, switch to a spare battery pack, or use external power. Press OK to turn off.	The power-up battery check detects the battery charge is below five percent while on battery.
Battery power is less than 20%. You may need to recharge the 375 battery, switch to a spare battery pack, or use external power.	The power-up battery check detects the battery charge is below 20%, and more than or equal to 5% while on battery.
Communication circuit is not responding.	CDC is not responding during the power-up
Warning: System incompatibility detected - error code x. You may start Listen for PC mode and use the 375 Programming Utility to resolve this. Or You may turn off your 375 and contact service center to resolve this. (Where x is an error code indicating what the incompatibility detected was or related errors.)	Hardware version or Operating System is not compatible.
Installation file is corrupt - error code x. Please call service center to resolve this problem. Press OK to turn off. (Where x is an error code indicating which cab file size is bad, getting file size failure (which means file is missing), TAZrev.xml file checksum failure, or other related errors.)	The .cab files size check or TAZrev.xml checksum check failed before it attempted to launch the program loader.
The 375 needs to update its software. Battery power must be more than 20% to allow for this update. You must recharge the 375 battery, switch to a spare battery pack, or use external power. Press OK to turn off.	This message occurs when on battery, and the battery percentage is less than 20% before attempting to launch program loader:
This 375 is not licensed for HART.	You are not licensed for HART functionality.
This 375 is not licensed for FOUNDATION Fieldbus.	You are not licensed for FOUNDATION fieldbus functionality.
The 375 does not detect a System Card. Please make sure your System Card is properly installed in its slot. Press OK to turn off.	This message occurs when the System Card is not properly installed in its slot.
HART Error and Help Messages	Description
"Poll Using Long Tag" allows the user to enter the long tag of the device they want to connect to	This is a help message.
"Poll Using Tag" allows you to enter the tag of the device you want to connect to	This is a help message.
Enter Device Long Tag	This is a help message.
Enter the long tag that corresponds to the device you want to connect to	This is a help message.
Hart Application Error... "hc.dll device revision x not found."...Refresh System Card...See User's Manual and Programming Interface for details	This error message appears when an expected version of hc.dll is not found.

Hart Application Error... "registry failure"...Reinstall System Files...See User's Manual for details	This error message appears when the information describing the location of the DD's is not found in the registry.
Voltage is currently detected at the Fieldbus Terminals. Reconfigure unit and try again.	This error message appears when the HART app found voltage on the FF connector during initialization and during reconnection to a device.
CDC Error..."failure while switching to HART"...Reinstall System Files...See Users's Manual for details	This error message appears when the HART app fails to put the CDC in HART mode for talking to a HART device.
DD Error..."tokenizer mismatch"...DD version <manufacture name, device name, dev. rev. #, and DD rev. #>; HART application <version x.y>; HART app version x.y...Reinstall DD...see Programming Interface for details	This error message appears when the version of the tokenizer used to tokenize the DD is not what the HART app expects.
DD Error..."linker mismatch"...DD version x.y; HART app version x.y...Reinstall DD...see Programming Interface for details	This error message appears when the version of the linker used to link the DD is not what the HART app expects.
DD Error..."developed-to mismatch"...DD version <manufacture name, device name, dev. rev. #, and DD rev. #>; HART application <version x.y> ...see Programming Interface for solution.	This error message appears when the DD was developed and tested using a later HART app revision.
Warning: this DD is untested with the current Hart App ver <manufacture name, device name, dev. rev. #, and DD rev. #>...you may experience unexpected or inappropriate results...see Programming Interface for details on DD updates...Do you want to accept these risks and proceed?	This error message appears when the DD was not tested and verified with the HART app.
DD Error..."tested-to sequence mismatch"...DD version <manufacture name, device name, dev. rev. #, and DD rev. #>; HART application <version x.y>; HART app version x.y...see Programming Interface for solution	This error message appears when the DD was tested with a previous version but not with this version of the HART app
DD Error..."developed-to mismatch"...DD version <manufacture name, device name, dev. rev. #, and DD rev. #>; HART application <version x.y>; HART app version x.y...Reinstall DD...see Programming Interface for details	This error message appears when the DD was developed using a later HART app revision.
DD Error..."DD header file corrupted"...Reinstall Device version <manufacture name, device name, dev. rev. #, and DD rev. #>; HART application <version x.y> ...see Programming Interface for details	This error message appears when there is a check sum error in the DD header file.
Hart Application Error..."data compression dll is missing"...Reinstall System Files...See User's Manual for details	This error message appears when the data compression component can not be located.
Hart Application Error..."data compression dll is corrupted"...Reinstall System Files...See User's Manual for details	This error message appears when a required functionality is missing from the data compression component.
Memory Error..."data compression memory allocation error"...Restart Unit...See User's Manual for further details	This error message appears when HART app is unable to acquire enough memory for data compression.

<p>DD Error..."failure while opening DD"...Reinstall Device Type x Device Rev x dd Rev x...see Programming Interface for details</p>	<p>This error message appears when the system can not open the DD file.</p>
<p>DD Error..."failure while uncompressing DD"...Reinstall Device revision <manufacture name, device name, dev. rev. #, and DD rev. #> ...see Programming Interface for details</p>	<p>This error message appears when an error is detected while uncompressing the DD.</p>
<p>Communication Error..."unexpected return value"...See User's Manual for solution</p>	<p>This error message appears when an expected value returned from a function call.</p>
<p>DD Error..."DD file corrupted"...Reinstall Device revision <manufacture name, device name, dev. rev. #, and DD rev. #>...see Programming Interface for details</p>	<p>This error message appears when the checksum of the DD does not match with that described in the DD header file.</p>
<p>Forward Compatibility Blocked...DD Device Type x Device Rev x dd Rev x cannot be used in forward compatibility mode...x... Do you wish to proceed in forward compatibility mode?</p>	<p>This error message appears when the HART app attempts to use a DD to run in forward compatibility mode and finds that the DD is prevented from running in forward compatibility mode</p>
<p>DD Not Installed...DD device type x device rev x is not installed on the System Card...see Programming Interface for details on DD updates...Do you wish to proceed in forward compatibility mode?</p>	<p>This error message appears when the DD for the connected device is not in the unit.</p>

**REQUIRED
INFORMATION
FOR
TECHNICAL
ASSISTANCE**

Before you call for technical support personnel, have the following information and answers to the following questions ready.

- Manufacturer and model of Control System (as applicable)
- 375 Field Communicator software revision
- Manufacturer and model revision of field device
- Loop diagram of the problem loop
- Plant layout diagram(s). What is the proximity to other equipment?
- Does HART Communication work when certain devices or processes are not running?
- What is the total cable length run from the termination panel to the Field device?
- What is the message on the 375 Field Communicator when attempting to communicate with a field device? (i.e. device not found)
- How many HART loops are there in the facility?
- How many HART loops are failing (i.e. no communication)?
- How much resistance (Ohms) is in the HART loop?
- User's Manual for the field device

Contacting Technical Support Personnel

Contact your supplier or go to the website, www.fieldcommunicator.com, for a list of technical support locations.

APPENDIX A REFERENCE INFORMATION

PROCESSOR AND MEMORY SPECIFICATIONS

Microprocessor 133 Mhz Hitachi® SH3

Memory **Internal Flash**

32 MB

System Card

128 MB (or higher) Secure Digital card

RAM

32 MB

Expansion Module

32 MB (or higher) Secure Digital card

PHYSICAL SPECIFICATIONS

Weight Approximately 2 lb. (950 grams) with battery

Display 1/4 VGA (240 by 320 pixels) monochrome touch screen with a viewing area of approximately 9 cm by 12 cm (14.8 cm diagonal)

Base glass thickness 1.1 mm anti-glare

Dimensions 85.5 mm x 54.0 mm x 8.26 mm

Keypad Twenty-five keys including four action keys, twelve alphanumeric keys, four alternate functionality keys, on/off, and 4 navigation (arrow) keys; membrane design with tactile feedback

**POWER
SUPPLY
SPECIFICATIONS**

Power supply voltage

6.0 V

Battery

Five rechargeable NiMh AA batteries
Sealed for Intrinsic Safety purposes.
Not customer serviceable.

Battery operating time

Ten hours typical use

Battery Charger

110/120 vAC, 60 Hz, U.S. plug
220/240 vAC, 50 Hz, European plug
220/240 vAC, 50 Hz, U.K. plug

**CONNECTION
SPECIFICATIONS**

Battery Charger

2.5 mm jack

HART and Fieldbus Communication

Three 4mm banana plugs (One common to both
HART and FOUNDATION fieldbus.)

Personal Computer

IrDA port supporting up to 115 Kb/s
 ± 15 degrees recommended maximum angle from
center line.

18 in. recommended maximum distance from
center line.

**ENVIRONMENTAL
SPECIFICATIONS****Usage**

-10°C to +50°C

0% to 95%RH (non condensing) for 0°C to +50°C

Charge

0°C to +40°C

Storage

-20°C to +55°C with batteries
(less than one month)

Storage without batteries

-20°C to +60°C

Enclosure rating

IP51 (front)

Shock

Will survive a 1-meter drop test onto concrete

**ORDERING
INFORMATION**

Up-to-date ordering and spare part information can be found on the 375 Field Communicator website, www.fieldcommunicator.com.

APPENDIX B APPROVAL INFORMATION

OVERVIEW	This Appendix contains information on approved manufacturing locations, the European Directive, Hazardous Locations Certifications, and approval drawings for HART protocol.
APPROVED MANUFACTURING LOCATIONS	Emerson Process Management — Leicester, England
EUROPEAN DIRECTIVE INFORMATION	
Equipment and componet directive (94/9/EC)	Emerson Process Management complies with the ATEX Directive. Specific ATEX Directive Information is located within this appendix. CE Compliance per EN 50014, EN 50020, and EN 50284
Electro Magnetic Compatibility (89/336/EWG)	Tested to specifications EN 61000-6-3 and EN 61000-6-2
Other important guidelines	Only use new, original parts. Do not charge the battery in hazardous areas. Have repairs done only by qualified personnel. Only charge or power using the 375 Power Supply.

HAZARDOUS LOCATIONS CERTIFICATIONS

North American Certifications

Factory Mutual (FM)

Approval pending. Intrinsically Safe for Class I, Division 1, Groups A, B, C, and D. Non-Incendive for Class I, Division 2, Groups A, B, C, and D.

Figure B - 1. FM Intrinsically Safe Configuration (Ungrounded)

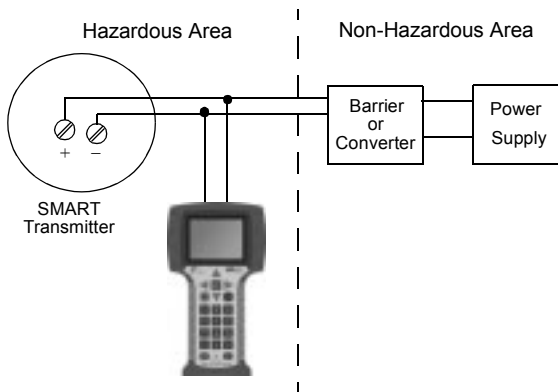
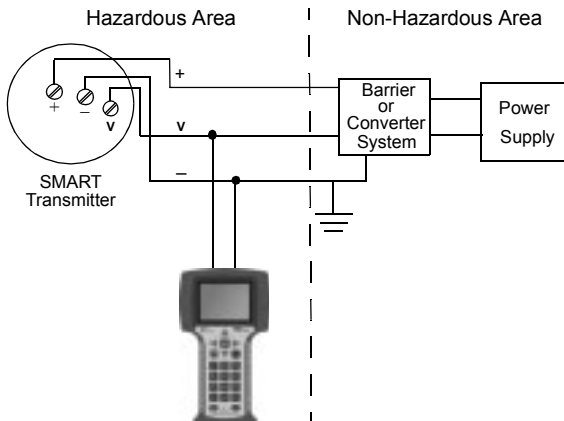

Figure B - 2. FM Intrinsically Safe Configuration (Grounded)



Canadian Standards Association (CSA)

Approval pending. Intrinsically safe for use in Class 1, Division 1, Groups A, B, C, and D hazardous locations when connected to CSA-certified intrinsic safety barriers as indicated the control drawing.

**European
Certifications****CENELEC Intrinsic Safety**

Certification No.: DMT 03 ATEX E 031

 II 2 G (1 GD)

EEx ia IIC T4

(Tamb = -10 °C to +50 °C)

HART Intrinsically Safe electrical parameters**Input Parameters**

$U_i = 30$ Volt DC

$I_i = 200$ mA

$P_i = 1.0$ Watt

$L_i = 0$

$C_i = 0$

Output Parameters

$U_0 = 0.4$ Volt DC

$I_0 = 0.3$ nA

Special conditions for safe use:

The intrinsically safe bus circuits type of protection EEx ia II can be connected to apparatus which are located in area where combustible dust can be present. It must be sure, that only apparatus may be connected to those circuits which are designed and certified for use in category 1D or 2D.

GLOSSARY

Alphanumeric

A character set that contains both letters and digits and, usually, other characters, such as punctuation marks.

AMS

A suite of software for remotely managing SMART® field devices over existing HART or FOUNDATION fieldbus networks. You can use AMS to monitor devices, configure devices, maintain calibration results, run diagnostic routines, and maintain historical data.

CDC

Communication Diagnostic Circuitry

CENELEC

European Committee for Electrotechnical Standardization

Device configuration

Parameters that define the physical attributes and operating characteristics of a device.

Device Description (DD)

A set of instructions written in the HART or FOUNDATION fieldbus Device Description Language that defines the parameters and commands that a host application needs to communicate with a HART or FOUNDATION fieldbus field device.

DDL

Device Description Language. A specialized programming language used to write Device Descriptions for HART or FOUNDATION fieldbus-compatible field devices. See *also* Device Description.

Expansion Module (EM)

An optional removable memory card that snaps into the Expansion Port on the side of the 375 Field Communicator. See ordering information for availability types.

Field device

Field devices may generate or receive an analog signal in addition to the HART digital communication signal.

Fieldbus Foundation

The organization that develops and supports FOUNDATION fieldbus, an international, interoperable standard for communication of process automation and control information. Members include suppliers and end users of process control and manufacturing automation products. Support for the standard includes education, interoperability and conformance testing, testing tools, and development software.

Internal Flash

The memory that stores the OS, an application software that also stores twenty-five HART device configurations, HART event captures, fieldbus statistics, and user generated text files.

Intrinsic Safety

The concept of Components device whereby the device is designed to limit the amount of energy consumed or provided to field devices to levels below those that are required to ignite specific types of hazardous materials under fault and no fault conditions.

FOUNDATION fieldbus

Foundation Fieldbus is a specific fieldbus technology developed and supported by Emerson Process Management and the other members of the independent Fieldbus Foundation. Foundation Fieldbus

technology uses Device Descriptions and function blocks to enable intelligent field devices to execute control functions traditionally performed by a distributed control system.

HART device

A device that communicates information using the HART protocol.

HART loop

A communication network in which the master and slave device are HART-smart or HART-compatible.

HART protocol

Highway Addressable Remote Transducer communication protocol. An industry-standard protocol for digitally enhanced 4–20 mA communication with “smart” field devices.

HART tag

An 8-character field used to identify a device. A 32-character long tag is also possible with HART Universal revision 6 device. This field is stored in the HART device and can be modified.

Intrinsic Safety (IS)

A method of providing safe operation of electronic process-control instrumentation in hazardous areas, such as flammable environments. IS systems keep the available electrical energy in the system low enough that ignition of the hazardous atmosphere cannot occur.

Intrinsic Safety barrier

A physical entity that limits the current and voltage into a hazardous area in order to satisfy Intrinsic Safety requirements.

IrDA

Infrared Data Association, a non-profit trade association that establishes standards for infrared communications between devices such as personal computers, printers, and handheld devices.

Personal Computer (PC)

Synonymous with microcomputer, a computer that serves one user in the office or the home. PCs are the largest installed base of personal computers. Macintosh is second.

Polling

A method of sequentially interrogating a network to determine which devices are present.

Process variable (PV)

A process parameter that is being measured or controlled (for example, level, flow, temperature, mass, or density).

Segment (Fieldbus only)

The section of a Fieldbus that is terminated in its characteristic impedance. Segments are linked by repeaters to form a complete Fieldbus.

System Card

An internal Secure Digital Card with non-volatile Flash memory. A copy of installable 375 Field Communicator application software exists on every SC. The SC memory also stores all HART and FOUNDATION fieldbus Device Descriptions.

User data file

A text (.TXT) file created by a user either on a PC or with the ScratchPad application on the 375. User data files can be transferred between the 375 Programming Utility and a 375.

INDEX

Symbols

- .rec files 2-11
- .txt file G-iv
- .txt files 2-16

Numerics

- 375 Main Menu 2-9

A

- About 375 2-10
- Alphanumeric keypad 2-5, 2-7
- AMS 2-14, G-i
- Analog output 3-18
- Approval information B-1
- Arrow
 - Back 2-9
- ATEX B-1

B

- Back arrow 2-9
- Backlight 2-10
 - Key 2-5, 2-7
- Basic
 - Features 2-5, 3-2
 - Functions 2-5, 3-2
- Basic Setup 3-16
- Battery 2-21
 - Charge 2-12, 2-21, 2-22
 - Charger A-2
 - Indicator button 2-2
 - Operating time A-2
 - Pack 2-2
 - Specifications A-2
- Battery pack 2-22

- Brightness, see Backlight 2-10

Button

- FILTR 3-7
- Home 3-15
- Hot Key 3-3
- Terminate 2-9
- XPAND 3-8

C

- Calibration 3-16
- Canadian Standards Association B-3
- CDC G-i
- CENELEC Intrinsic Safety B-3, G-i
- Charge A-3
- Charger 2-22
 - Battery A-2
 - Connection 2-5
- Cleanup 3-20
- Clock 2-11
- Communication 2-14
 - Terminals 2-5
- Communication and Diagnostic Circuitry (CDC) 2-10
- Comparing
 - HART configurations offline 3-10
- Components 2-5
- Configuration
 - Comparing 3-10
 - Copying 3-9
 - Creating new 3-5
 - Deleting 3-9
 - HART offline 3-8

- Offline configurations 3-5
- Opening 3-7
- Renaming 3-10
- Connecting
 - Load resistor 3-14
 - Power supply/charger 2-5
 - Specifications A-2
- Contrast 2-11
- Copying
 - HART configurations offline 3-9
- Copying text 2-18
- Cutting text 2-18
- D**
- D/A trim 3-16
- Damping 3-16
- Date/Time 2-11
- DDL G-ii
- Deleting 2-19
 - Document 2-19
 - HART configurations offline 3-9
- Detailed Setup 3-17
- Device
 - Configuration 2-20, G-i, G-ii
 - Description 2-15, G-i, G-iv
 - Descriptions 3-21
 - Setup 3-16
- Device descriptions 2-20
- Diagnostics and Service 3-16
- Disconnecting
 - HART 3-22
- Display A-1
- Display, see Touch screen 2-5
- Document 2-17
 - Deleting 2-19
 - Opening 2-19
- E**
- Easy Upgrade 2-15
- Edit
 - HART configurations offline 3-8
- Electro Magnetic Compatibility B-1
- Enclosure rating A-3
- Enter key 2-5, 2-6
- Entering text 2-17
- Environmental specifications A-3
- Equipment and component directive B-1
- Error 4-5
- European Certifications B-3
- European Directive Information B-1
- Event capture 2-11, 2-20, G-ii
- Exiting
 - ScratchPad 2-19
- Expansion Module 2-20, 3-20, A-1, G-ii
- Expansion port 2-5
- F**
- Factory Mutual B-2
- Fast key 3-2
- Features 2-5, 3-2
- Field device G-ii
- Fieldbus 1-2
- Fieldbus Foundation G-ii
- File
 - Management 2-20
 - Transferring 2-15
- Filter
 - Sort 3-7
 - Tag 3-7
- FILTR button 3-7
- Flash, see Internal Flash 2-20
- Foundation fieldbus 1-2, 2-12, G-ii
- Function key 2-5, 2-8
- Functions 2-5, 3-2
- H**
- HART
 - Application 3-14
 - Comparing offline 3-10
 - Copying offline 3-9
 - Deleting offline 3-9
 - Disconnecting 3-22
 - Editing offline 3-8
 - Functionality 3-1
 - Icon 3-2
 - Load resistor 3-14
 - Loop 3-13, G-iii
 - New configuration 3-5
 - Offline 3-5
 - Open configurations 3-7
 - Polling 3-18
 - Protocol G-iii
 - Renaming offline 3-10
 - Simulation 3-21

- Starting application 3-2
- Tag G-iii
- Utility 3-18
- HART Application
 - Running 2-10
- HART device G-iii
- HART loop
 - Connecting 3-11
 - Terminals 3-12
- Hazardous Locations Certifications B-2
 - CENELEC B-3
 - CSA B-3
 - FM B-2
- Home button 3-15
- Hot Key 3-3
 - Cleanup 3-20

I

- Ignored status 3-20
- Installation
 - Battery Pack 2-2
 - System Card 2-2
- Internal Flash 3-20, A-1, G-ii
- Intrinsic Safety G-ii
- Intrinsic safety G-iii
 - Barrier G-iii
- Introduction 1-1
- IrDA 2-14, 2-15, G-iii
 - Adapter 2-14
- IrDA interface 2-5

K

- Key
 - Alphanumeric Keypad 2-7
 - Alphanumeric keypad 2-5, A-2
 - Backlight 2-5, 2-7
 - Enter 2-5, 2-6
 - Fast key sequences 3-2
 - Function 2-5, 2-8
 - Hot Key Options 3-3
 - Keyboard, see Soft Input Panel 2-9
 - Navigation 2-5, 2-6
 - On/off 2-5, 2-6
 - Tab 2-5, 2-6
- Keypad 2-5
- Keypad, see Alphanumeric keypad 2-6

L

- LED 2-5, 2-8, 2-13
- License 2-12
 - AMS 2-15
- Listen for PC 2-14
- Load resistor 3-14
- Loop
 - HART 3-13, G-iii
 - Troubleshooting 4-2
- Loop test 3-16
- Lower range value 3-18

M

- Maintenance 2-21
- Managing files 2-20
- Manufacturing locations B-1
- Memory 2-12, 2-20
 - Specifications A-1
- Menu trees 3-1
- Messages
 - Error 4-5
 - Safety 2-1, 3-1
 - Status messages 4-5
- Modes
 - Listen for PC 2-14
- Multifunction LED 2-5, 2-8, 2-13

N

- Navigation keys 2-5, 2-6
- New document 2-17
- North American Certifications B-2

O

- Offline
 - HART 3-5
- On/off key 2-5, 2-6
- Online 3-11
 - Menu 3-14
 - Simulation 3-21
- Opening
 - Document 2-17, 2-19
 - Saved configurations 3-7
- Operating system 2-10
- Ordering information A-3

P

- Parts 2-5, A-3
- Pasting text 2-18
- Personal Computer A-2, G-iv
- Physical specifications A-1
- Polling 3-18, G-iv
- Power 2-12
 - Supply 2-5, 2-22
 - Specifications A-2
 - Voltage A-2
- Primary variable 3-17
- Process variable G-iv
- Process variables 3-16
- Processor A-1
- Processor specifications A-1
- Programming Utility 2-12, 2-14, 2-15
- Protocol
 - HART G-iii

R

- RAM 2-20, A-1
- Range values 3-16
- Reference A-1
- Re-Flash 2-2, 2-10
- Renaming
 - HART configurations offline 3-10
- Repair 2-21
- Replacement 2-21
- Resistance
 - Troubleshooting 4-2
- Resistor 3-14
- Review 3-17

S

- Safety Messages 2-1, 3-1
- Saving text 2-18, 2-19
- Scaled D/A trim 3-16
- ScratchPad 2-16
 - Copying text 2-18
 - Cutting text 2-18
 - Entering text 2-17
 - Exiting 2-19
 - New 2-17
 - Opening 2-17, 2-19
 - Pasting text 2-18
 - Saving text 2-18, 2-19
 - Selecting text 2-17

- Undoing text 2-18
- Screen
 - Backlight 2-10
- Segment G-iv
- Selecting text 2-17
- Self test 2-22
- Sensor trim 3-16
- Settings
 - About 375 2-10
 - Backlight 2-10
 - Clock 2-11
 - Contrast 2-11
 - Event capture 2-11
 - License 2-12
 - Memory 2-12
 - Power 2-12
 - Running 2-10
 - Touch screen 2-13
- Shock A-3
- Shutting down 2-3
- Soft Input Panel (SIP) 2-9
- Sort 3-7
- Spare part A-3
- Specifications A-1
 - Battery A-2
 - Charge A-3
 - Charger A-2
 - Communication A-2
 - Connection A-2
 - Display A-1
 - Enclosure rating A-3
 - Environmental A-3
 - Expansion Module A-1
 - Internal Flash A-1
 - Keypad A-2
 - Memory A-1
 - Personal Computer A-2
 - Physical A-1
 - Power supply A-2
 - Processor A-1
 - RAM A-1
 - Shock A-3
 - Storage A-3
 - System Card A-1
 - Usage A-3
 - Weight A-1
- Starting up 2-3, 2-10

Status

- Messages 3-1, 4-5
- Number of Ignored 3-20

Storage A-3

- Cleanup 3-20
 - Device configurations 2-20, G-ii
 - Files 2-20
 - Internal Flash 2-20
 - Types 2-20
- Stylus 2-5, 2-9
- System Card 2-20, 2-22, A-1, G-iv
- Installation 2-2
- System software 2-10

T

- Tab key 2-5, 2-6
- Tag 3-16, 3-17
- filter 3-7
 - HART G-iii
 - Polling 3-19
- Terminals 2-5, 3-12, A-2
- Terminate button 2-9

Test

- Device 3-16
- Loop 3-16
- Self 2-22

Test device 3-16**Text**

- Copying 2-18
- Cutting 2-18
- Deleting a document 2-19
- Entering 2-17
- Opening 2-19
- Paste 2-18
- Saving 2-18, 2-19
- Selecting 2-17
- Undoing 2-18

Time/Date 2-11**Touch screen**

- Alignment 2-13
- Display 2-5
- Using 2-8

Transferring files 2-15**Trim**

- D/A 3-16
 - Scaled D/A 3-16
 - Sensor 3-16
- Troubleshooting 4-1

U

- Undoing text 2-18
- Upper range value 3-18
- Usage A-3
- USB 2-14
- User data file G-iv
- Utility
- HART 3-18

V

- Voltage 3-1, 3-22
- Troubleshooting 4-3

W

- Website 4-8
- Weight A-1
- Wireless communication 2-14
- Wiring
- Troubleshooting 4-4

X

- XPAND button 3-8



EMERSON
Process Management

Emerson Process Management
Asset Optimization Division
12001 Technology Drive
Eden Prairie, MN 55344 USA
www.fieldcommunicator.com

Emerson Process Management
00375-0047-0001



Rosemount
00809-0100-4276



©2003, Emerson Process Management.

The contents of this publication are presented for informational purposes only, and while every effort has been made to ensure their accuracy, they are not to be construed as warranties or guarantees, express or implied, regarding the products or services described herein or their use or applicability. All sales are governed by our terms and conditions, which are available on request. We reserve the right to modify or improve the designs or specifications of our products at any time without notice.

All rights reserved. The Emerson logo is a trademark and service mark of Emerson Electric Company. All other marks are the property of their respective owners.

